

DETAIL-A
SCALE 3:1

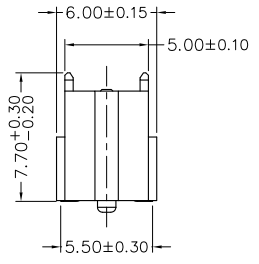
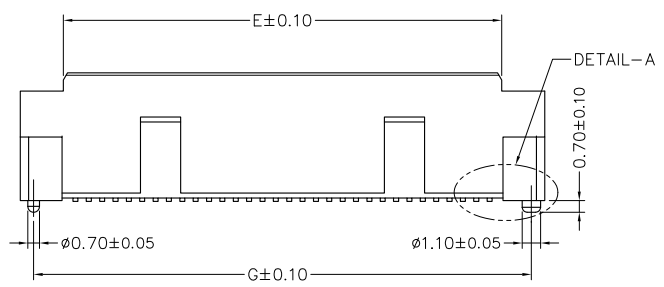

NOTE:

1. MATERIAL
 - 1.1 HOUSING: LCP, HIGH TEMPERATURE THERMOPLASTIC, UL94V-0 RATED. (COLOR: NATURE)
 - 1.2 TERMINAL: BRASS; T:0.20mm
 - 1.3 CAP: STAINLESS; T:0.20mm
2. TERMINAL FINISH
 - 2.1 CONTACT AREA: GOLD PLATING (SEE ORDERING INFORMATION)
 - 2.2 SOLDER AREA: TIN PLATING 80µ" MIN.
 - 2.3 UNDERPLATE PLATED: NICKEL 50µ" MIN.
3. CAP FINISH
NO PLATED

< ORDERING INFORMATION >

BP077 XXXX GXXF1 3 1

SERIES NO. _____
0.8 PITCH BOARD TO BOARD
7.7H PLUG CONNECTOR

CONTACT POS. _____
SEE DIM. TABLE

CAP OPTION
0: WITHOUT CAP
1: WITH WATER CAP

PACKAGE
2: TUBE
3: T&R

CONTACT PLATING
GOLD PLATING ON CONTACT AREA
MATTE-TIN (80µ" MIN.) ON SOLDER AREA
NICKEL (50µ" MIN.) UNDERPLATED OVER ALL.
G29F1: GOLD 4µ" MIN.
G30F1: GOLD 8µ" MIN.
G20F1: GOLD 15µ" MIN.

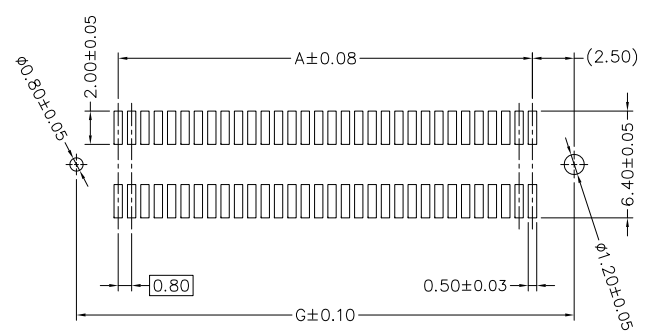

RECOMMENDED PCB LAYOUT WITH PEGS

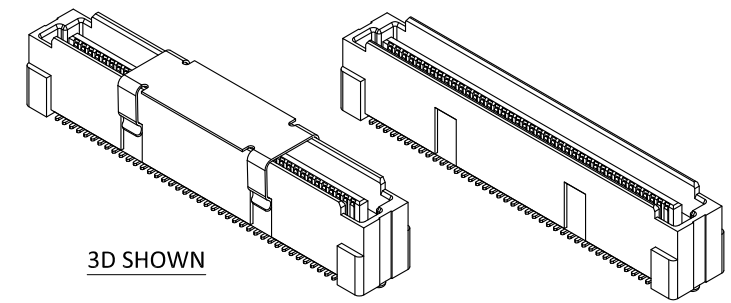

3D SHOWN

DIM. TABLE

ORDERING NO.	NUMBER OF POSITIONS	DIENSION						
		A	B	C	D	E	F	G
2032	2 X 32	24.80	26.40	28.60	29.90	26.25	31.40	29.80
2040	2 X 40	31.20	32.80	35.00	36.30	32.65	37.80	36.20
2060	2 X 60	47.20	48.80	51.00	52.30	48.65	53.80	52.20
2100	2 X 100	79.20	80.80	83.00	84.30	80.65	85.80	84.20

△	Revised	2016,12,30
⚠	New Version	2016,12,07
REV.	DESCRIPTION	DATE
DR. Shun	CHK.	APP. Peter

UNITS: MM

TOLERANCE (UNLESS SPECIFIED)
0.0 ±0.25
0.00 ±0.13
0.000 ±0.05
ANG. ±1



TITLE: 0.8 PITCH BOARD TO BOARD
7.7H PLUG CONNECTOR

DWG NO. BP077_P
FILE PATH BTB\BP077\BP077_P2
SHEET 1 / 2
REV. 2

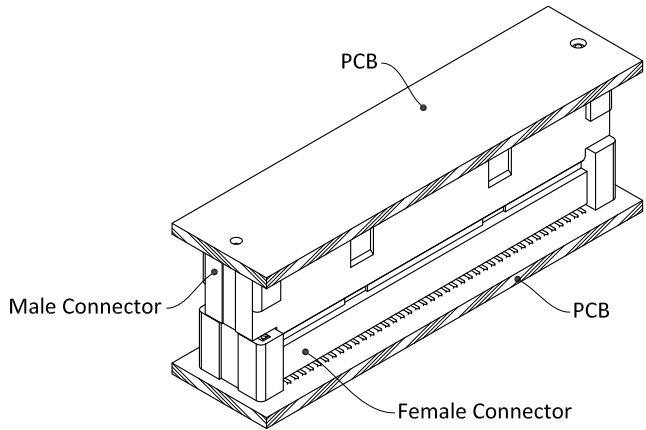

@ Mating Height Option Table

Connector Height(mm)		Mating Height(mm)
Male	Female	H
7.7	3.7	7.9
	7.7	11.90

MATING HEIGHT 3D SHOWN

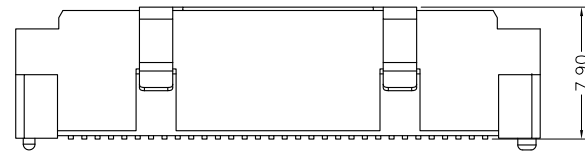
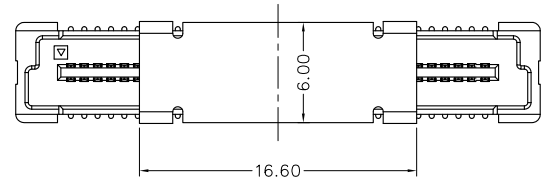
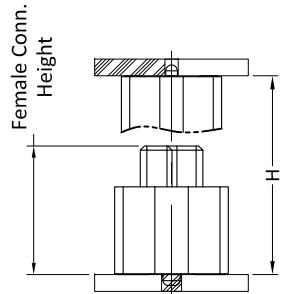
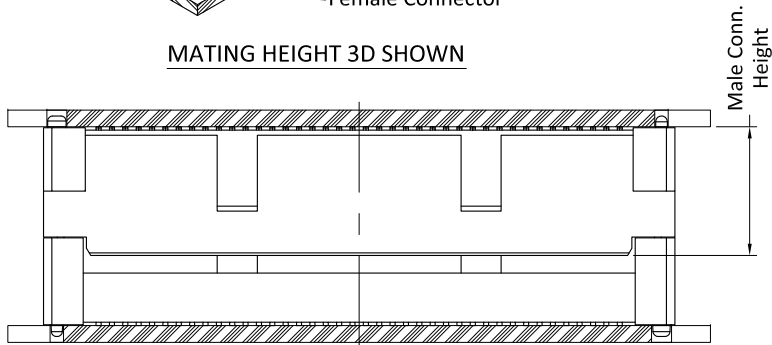

WITH CAP

△	Revised	2016,12,30
⚠	New Version	2016,12,07
REV.	DESCRIPTION	DATE
DR. Shun	CHK.	APP. Peter



TOLERANCE (UNLESS SPECIFIED)

0.0	±0.35
0.00	±0.20
0.000	±0.10
ANG.	±2°



TITLE: 0.8 Pitch Board To Board Mating Height Option

DWG NO. BP077_MHO
FILE PATH BTB\BP077\BP077-MHO_2

SHEET 1 / 1
REV. 2